

Output Current(A)

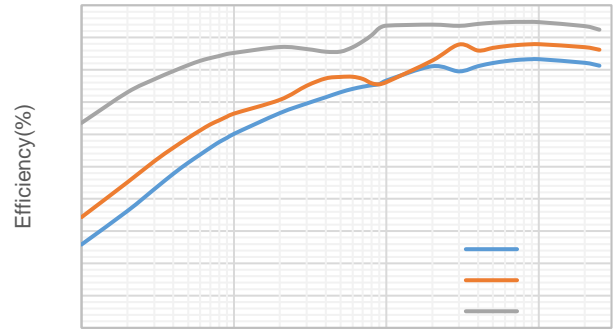

Output Current(A)

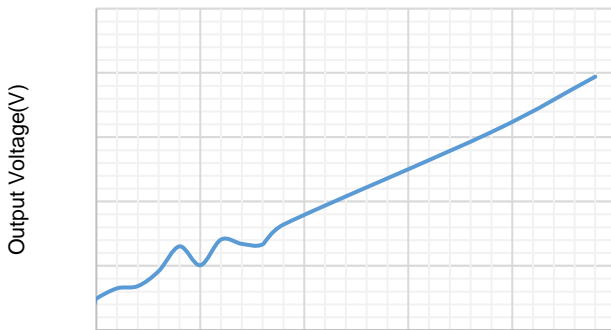

Output Current(A)

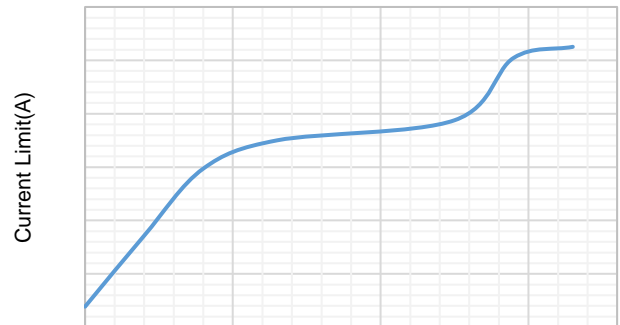

Temperature(°C)

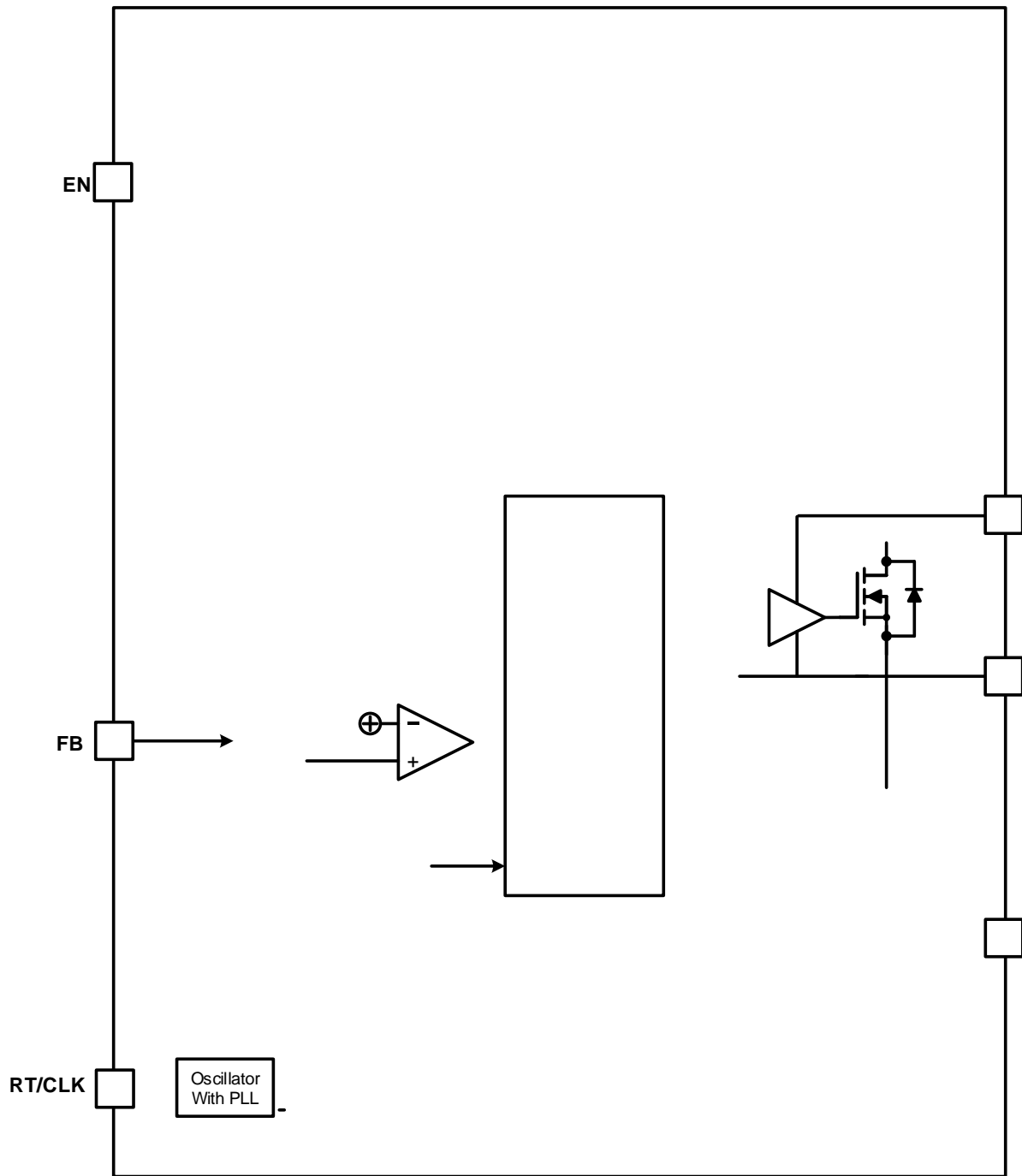

Overview

Peak Current Mode Control

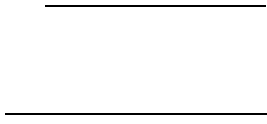

-
-

Output Voltage

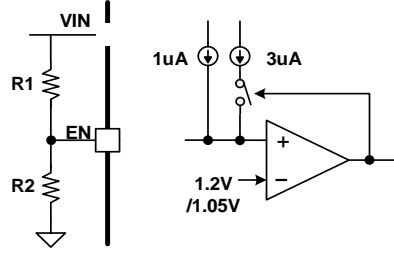

±

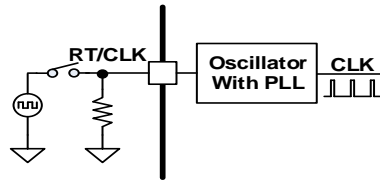

Bootstrap Voltage Regulator and Low Drop-out Operation

V LOW D J H G V Len BUSI f B) 0 Up P D S F D S D F L 0 D 0 0 \

° Ñ «¼ • R R Ü • ¼ H J X O D W R U









-
-
-
-
-
-



-

—

— —

— —

-
-
-





